

# 隔爆电磁换向阀 Explosion Isolation Electrical Operated Directional Control Valve

## 功能说明 Function Instruction

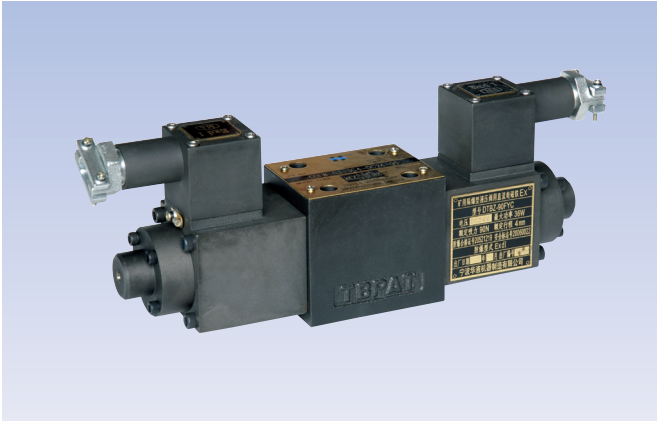

隔爆电磁换向阀是用电磁铁推动阀芯，从而变换流体流动方向的控制阀。

隔爆电磁换向阀可直接用在液压系统中，控制油路的通断和切换；也可作先导阀，用来操作其它阀。

隔爆电磁换向阀适用于防爆要求场合（如煤矿、石油、冶金、化工和工厂内存在B级-包含T1,T2,T3,T4组的可燃性气体；蒸气与空气形成的爆炸性混合物）的液压系统中作方向控制用

Explosion isolation electrical operated directional control valve uses solenoid to pull the spool and change the direction of the hydraulic oil.

Explosion isolation electrical operated directional control valve can directly control the flow on-off and change. It can also be used as the pilot-operated valve, which could operate other valves.

Explosion isolation electrical operated directional control valve which is used in the explosion isolation occasion (e.g. coal mine, oil, metallurgy, B level flammable gas including T1,T2,T3,T4 which exists in the factory and chemical, the explosive mixture of steam and air) can control the fluid direction in hydraulic system.

## 型号说明 Model description

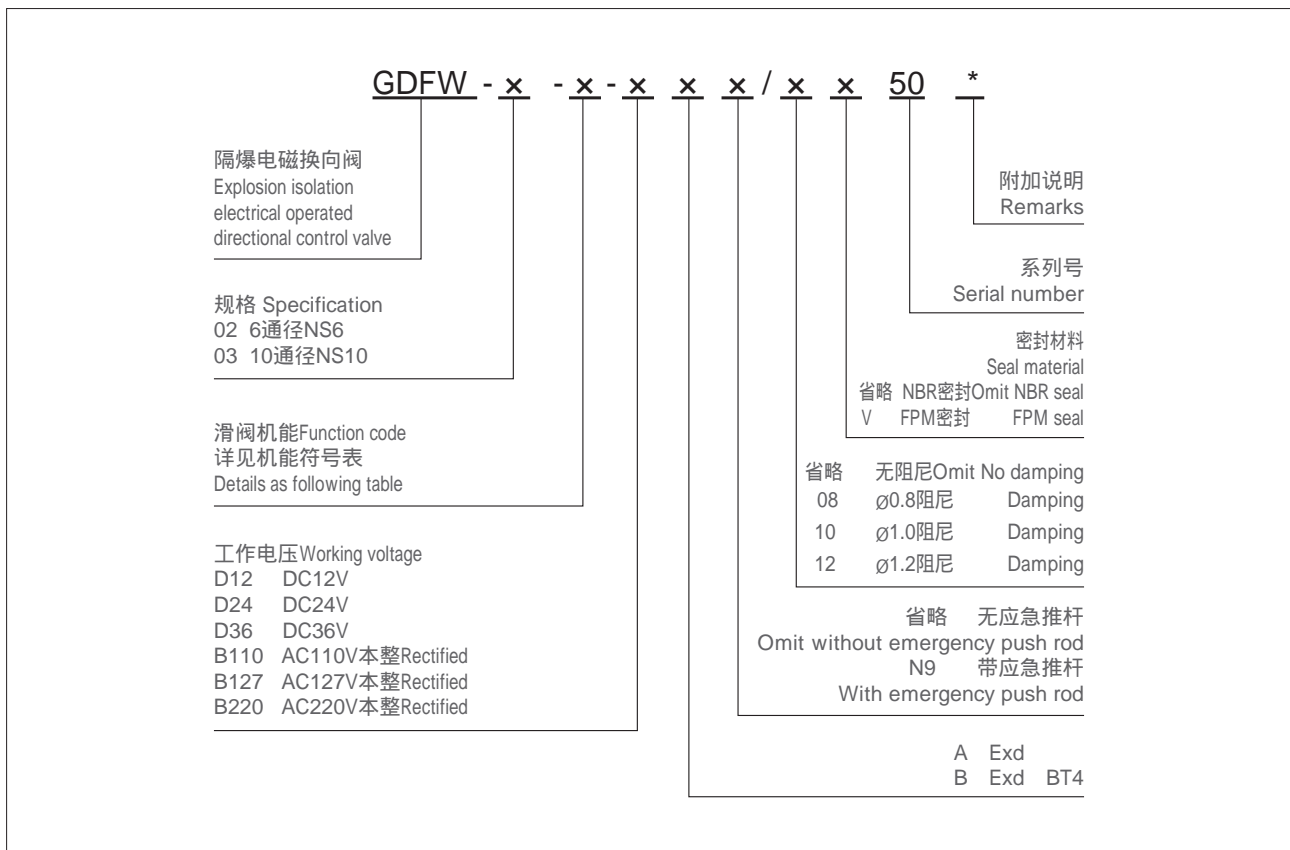

## 说明Explanation

- 规格 型电压等级有The voltage grade of specification type : DC24V DC36V AC127V
- 规格 型电压等级有The voltage grade of specification type : DC24V DC36V AC127V
- 规格 型 BT4电压等级有The voltage grade of specification type : DC12V DC24V AC110V AC220V
- 规格 型 BT4电压等级有The voltage grade of specification type : DC12V DC24V DC36V AC110V AC220V

# 机能符号 Code symbol

弹簧复位 Spring return

3C2		2B2B		2B2BL	
3C3		2B3B		2B3BL	
3C4		2B4B		2B4BL	
3C5		2B5B		2B5BL	
3C6		2B6B		2B6BL	
3C7		2B7B		2B7BL	
3C9		2B9B		2B9BL	
3C10		2B10B		2B10BL	
3C11		2B11B		2B11BL	
3C12		2B12B		2B12BL	
3C25		2B25B		2B25BL	
3C29		2B29B		2B29BL	

2B2	
2B3	
2B8	
2B2L	
2B3L	
2B8L	

## 机械定位 Mechanical position

2D2	
2D3	
2D8	

无复位弹簧无机械定位  
No return spring and no mechanical positioning

2N2	
2N3	
2N8	

注：\*D\*(无弹簧机械定位)机能电磁换向阀水平安装。  
其中03规格无2D2,2D3,2D8

Note: \*D\*( No return spring mechanical position) solenoid directional control valve should be installed horizontally.  
Among these types, there are no 2D2,2D3,2D8

# 电磁铁命名 Name of solenoid

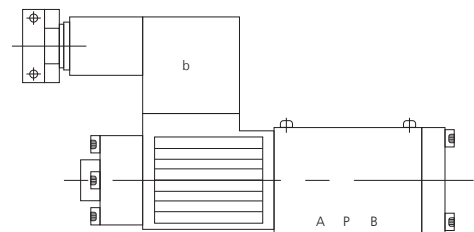
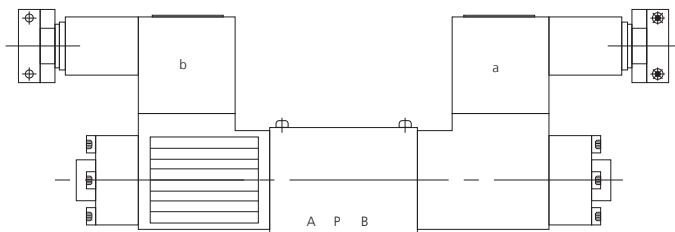

## 插头型式 Plug type

1. a动作时 When movement a, P A B T
2. b动作时 When movement b, P B A T
3. 3C5,3C6油液流通状况与上述方向相反  
Oil flow in the opposite direction with the above - mentioned movement.

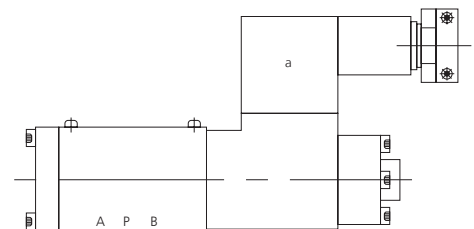

## 技术参数 Technical specification

		02	03
工作压力(Mpa)Working voltage	油口PAB Oil port PAB	31.5	
	油口T Oil port T	10	
最大流量Maximum flow(L/min)		80	120
工作介质Working fluid		矿物质液压油、磷酸酯 Mineral oil, phosphate-ester	
介质温度范围Fluid temp( )		-20~70	
介质粘度范围Viscosity(mm <sup>2</sup> /s)		2.8~380	
重量Weight(Kg)	单电磁铁Single solenoid	2.85	6.22
	双电磁铁Double solenoids	4.42	8.6
工作电压Working voltage(V)	直流Direct current	12 24 36	
	交流Alternating Current	127B 110B 220B	
循环时间Cycle time(ms)	开Open	25~45	50~60
	关 close	10~25	50~70
切换频率(次/小时)Switch frequency (t/h)		15000	
隔爆型式Explosion isolation type		Exd /Exd BT4	

## 02规格 D03 Specification

### 特性曲线Performance curve

(在  $\nu=41\text{mm}^2/\text{s}$ 和 $t=50$  下测得)Test under  $\nu=41\text{mm}^2/\text{s}$  and  $t=50$

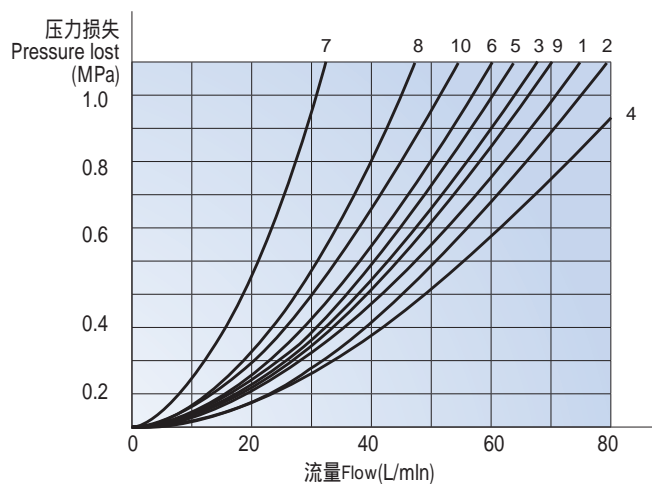

滑阀机能 Function code	流向Direction			
	P A	P B	A T	B T
2B8,2B8L	3	3	-	-
2B3	1	1	3	1
2B2,2B2L	5	5	3	3
3C2	3	3	1	1
3C5	1	3	1	1
3C6	10	10	9	9
3C3	2	4	2	2
3C4	1	1	2	1
3C10,3C12	3	3	4	9
3C9	2	3	3	3
3C25	3	1	1	1
3C29	5	5	4	-
3C7	1	2	1	1

工作范围曲线 (在电磁铁发热和欠电压10%情况下测得)

Working limit (Detected when the electro-magnet is in the heat and lack of 10% voltage)

由于阻塞的原因, 阀的切换性能取决于过滤。为了获得图示的最大流量值, 推荐采用 $25\ \mu\text{m}$ 的全流量过滤。阀内部液动力也影响流量特性, 因此对于四通阀, 图示流量数据适用于按有两个流动方

( P A B T )  
如将四通阀的A口或B口堵死而作三通阀用时, 在严重的情况下, 流量可能降低很大。

Because of block, the switching performance of the valve depends on the filtration. In order to obtain the maximum flow as in the curve, we recommend to use full-flow filter  $25\ \mu\text{m}$ . The flow may decrease a lot.

直流电磁铁操作DC solenoid operation D24, D12, B220, B110		交流电磁铁操作AC solenoid operation A110, A220, 50HZ	
曲线 Curve	符号 Symbol	曲线 Curve	符号 Symbol
1	2B8 2B8L1)	11	2B8 2B8L1)
2	3C7	12	3C7
3	2B8 2B8L	13	2B8 2B8L
4	3C5 3C25	14	3C5 3C25
5	3C4	15	3C6
6	3C6 3C3	16	3C3
7	2N8 2D8 3C10 3C12	17	2N8 2D8 2N3 2D3
8	2B3 2B2 2B2L		2N2 2D2 3C2 3C4 3C10
9	3C9		3C9 3C29 2) 3C12
10	3C2 3C29 2) 2N3 2D3 2N2 2D2	18	2B3 2B2 2B2L

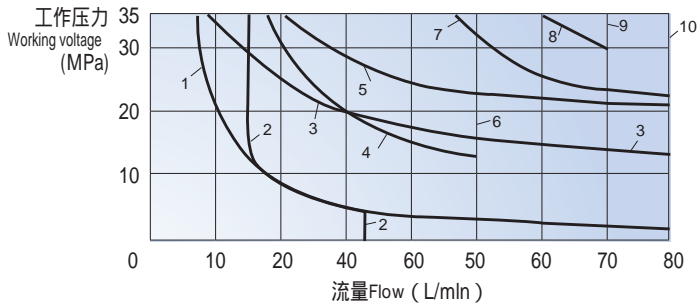

- 1) 无手动应急操作
- 2) 回油从执行器至油箱

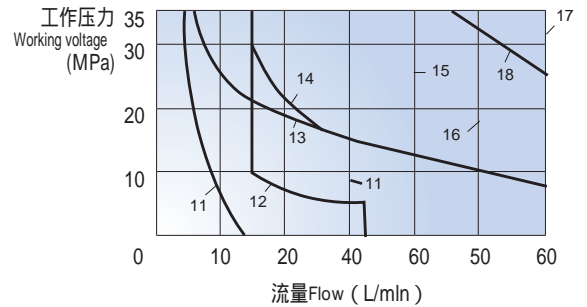

- 1) No manual emergency operation
- 2) Oil return from actuator to oil tank

## 03规格 D05 Specification

### 压力损失曲线 Pressure lost curve

(在  $v=41\text{mm}^2/\text{s}$  和  $t=50$  下测得) Test under  $v=41\text{mm}^2/\text{s}$  and  $t=50$  )

7 阀芯符号 3C29 处于切换位置 A ~ B  
4 阀芯符号 3C6 处于中位 P ~ T

7 Spool symbol 3C29 in the shifting position A ~ B  
4 Spool symbol 3C6 in the median position P ~ T

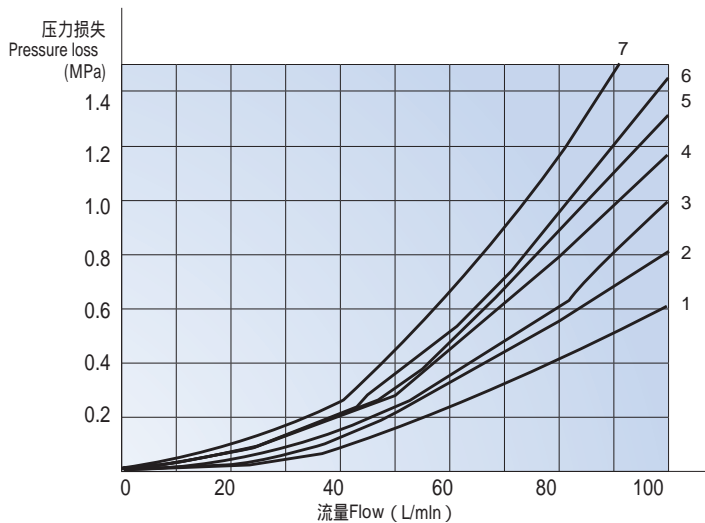

阀芯型式 Spool type	流动方向 Direction			
	P A	P B	A T	B T
2B8 2B8L	2	2	-	-
2B2 2B3 2B2L 3C4	2	2	3	3
3C2 3C7	2	2	4	4
3C5	2	3	3	5
3C6	3	3	4	6
3C3	1	1	4	5
3C10 3C12	2	2	3	5
3C9	1	1	5	1
3C25	3	2	5	3
3C29	2	4	3	-

工作极限 (在电磁铁发热和欠电压10%且回油箱无负载的情况下测得的)

Working limit (Detected when the electro-magnet is in the heat and lack of 10% voltage)

由于阻塞的原因，阀的切换性能取决于过滤。为了获得图示的最大流量值，推荐采用25 $\mu$ m的全流量过滤。阀内部作用力也影响流量特性，因此，对于四通阀，图示流量数据例如将四通阀的A口或B口堵死而作三通阀用时，在严重的情况下，最大流量可能很小。

Because of block, the switching performance of the valve depends on the filtration. In order to obtain the maximum flow as in the curve, we recommend to use full-flow filter 25  $\mu$  m. The flow maybe decrease a lot.

### 带直流电磁铁阀 With DC solenoid

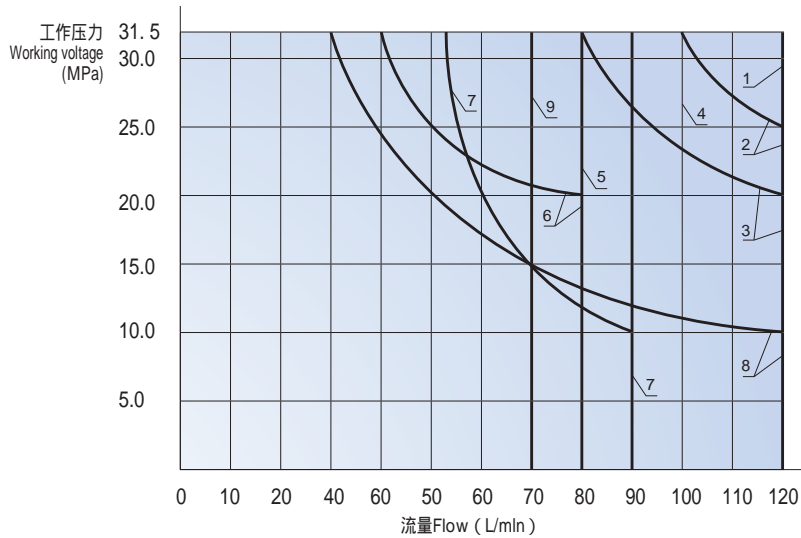

曲线 Curve	符号 Symbol
1	2B3 2N3 2D3 2B2 2N2 2D2 2B2L 3C9
2	3C2
3	2N8 2D8 3C10 3C12 3C4
4	3C3
5 <sup>1)</sup>	3C29
6	3C6
7	3C5 3C25
8	2B8 2B8L
9	3C7
1)	回路 (与面积比无关)

### 带交流电磁铁阀 With AC solenoid

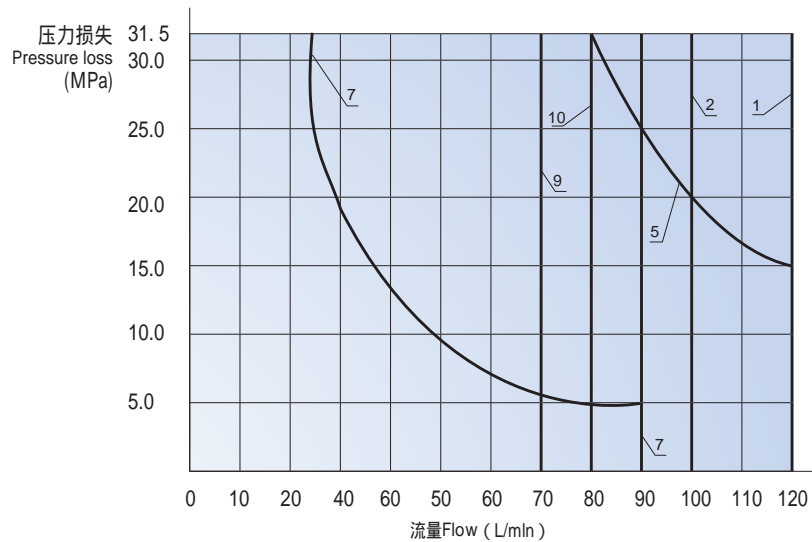

110V,50Hz;120V,60Hz; 220V,50Hz;240,60Hz;	
曲线 Curve	符号 Symbol
1	2B3 2N3 2D3 2B2 2N2 2D2 2B2L
2	3C2 3C10 3C12
3	3C9
4	2B8 2B8L
5	2N8 2D8 3C4
6	3C6
7	3C5 3C25
8	3C7
9	3C3
10	3C29

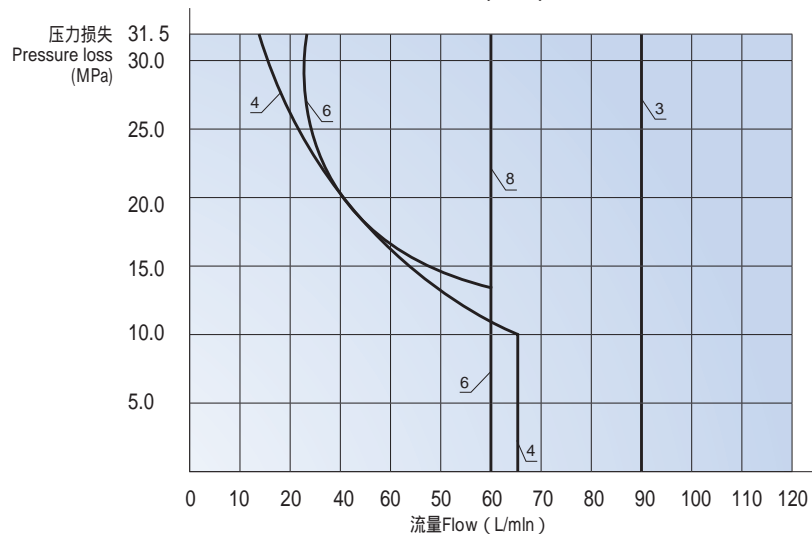

## 外形尺寸 Mounting size

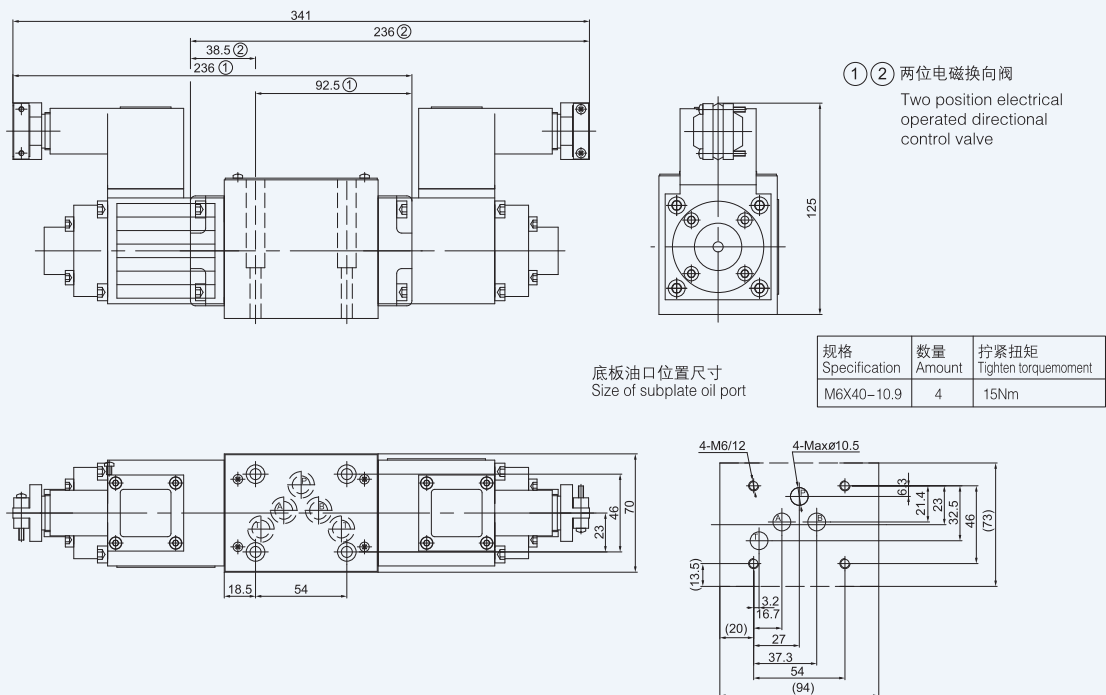
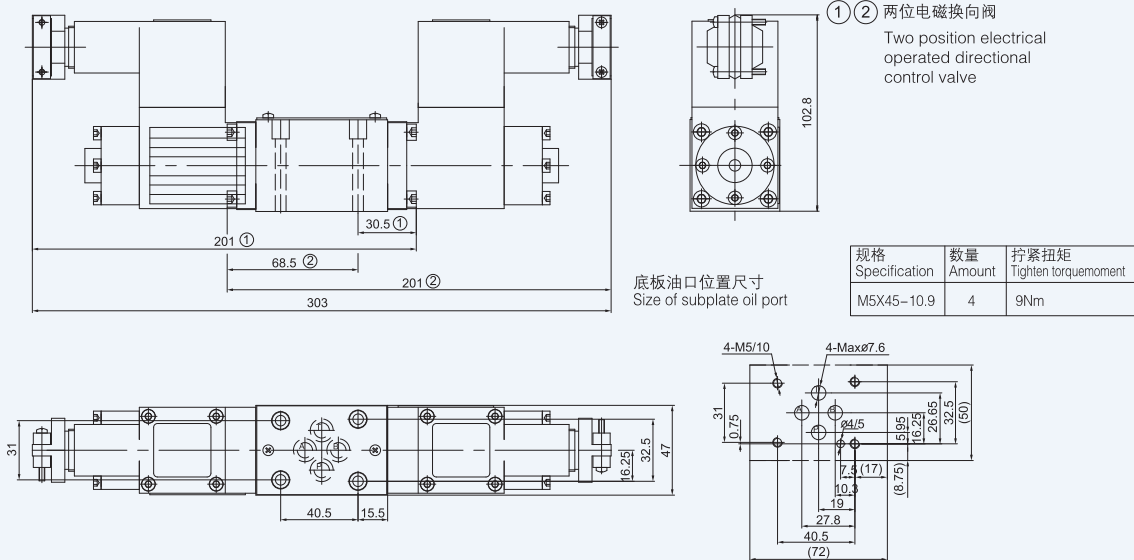

## 说明事项 Supplementary explanation

- 产品可任意安装，优先考虑水平位置。  
When Installing the product, considering horizontal position firstly.
- 液压系统所用介质必须过滤，过滤精度至少 $20\mu\text{m}$ 。  
The medium used in the hydraulic system must be filtered, its accuracy at least  $20\mu\text{m}$ .
- 固定螺钉请按样本中所列参数选用。  
Screw should be according to the parameters in catalogue.
- 与阀连接的表面，粗糙度要求 $\text{Ra}0.8$ ，平面度要求 $0.01/100\text{mm}$ 。  
The surface, connecting with the valve, should be  $\text{Ra}0.8$  roughness, and  $0.01/100\text{mm}$  flatness.