

叠加式单向阀 Modular Check Valve

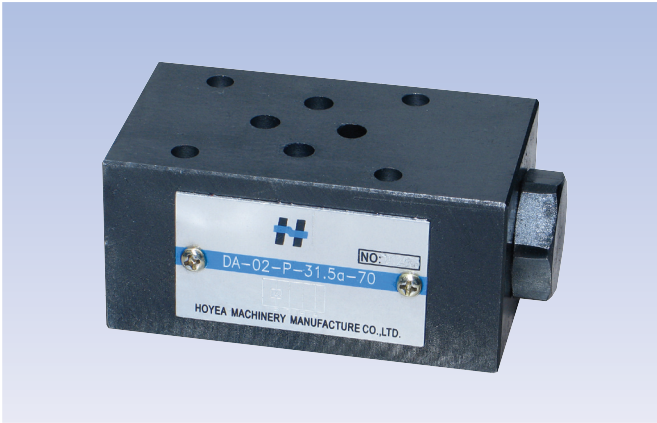

型号说明 Model description

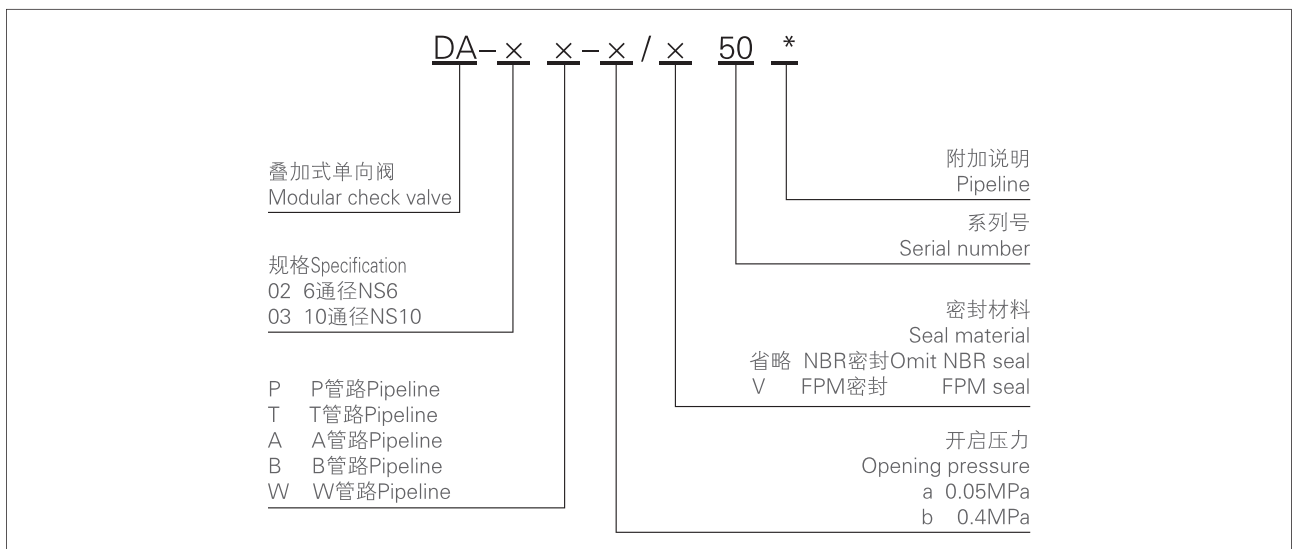

机能符号 Code symbol

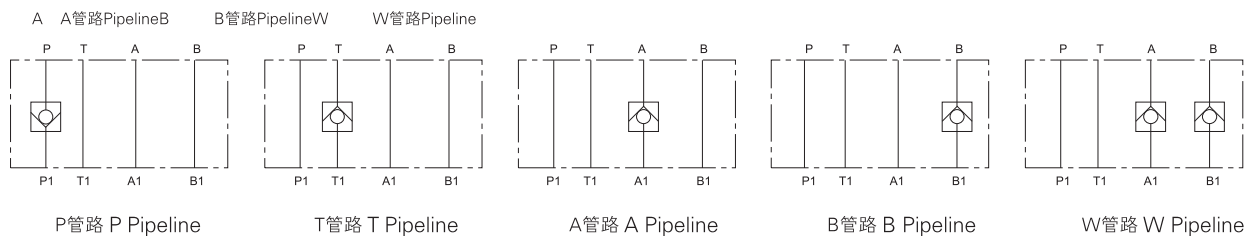

技术参数 Technical specification

规格Specification	02	03
最高工作压力Maximum working pressure(MPa)	31.5	
最大流量Maximum flow(L/min)	60	120
工作介质Working fluid	矿物质液压油、磷酸酯Mineral oil, phosphate-ester	
介质温度范围Fluid temp(°C)	-20 ~ 70	
开启压力Opening pressure(MPa)	a: 0.05 b: 0.4	
重量Weight(Kg)	1	2.7

02规格 D03 Specification

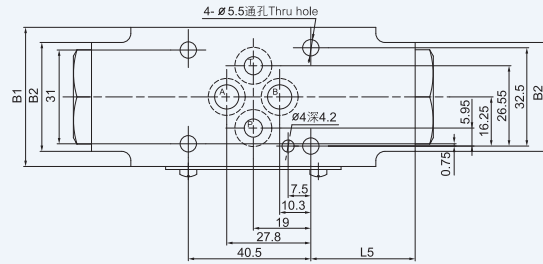
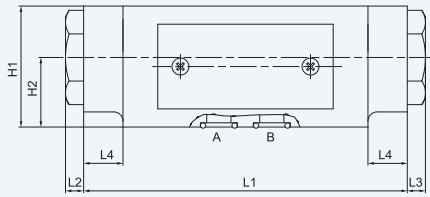

规格 Specification	参数 Parameter	B1	B2	H1	H2	L1	L2	L3	L4	L5
DA - 02 - A		46	-	40	20	80	6	-	-	20
DA - 02 - B		46	-	40	20	80	-	6	-	20
DA - 02 - P		46	-	40	20	80	-	6	-	20
DA - 02 - T		46	-	40	20	80	-	6	-	20
DA - 02 - W		46	36	40	23	107	6	6	13	34.5

03规格 D05 Specification

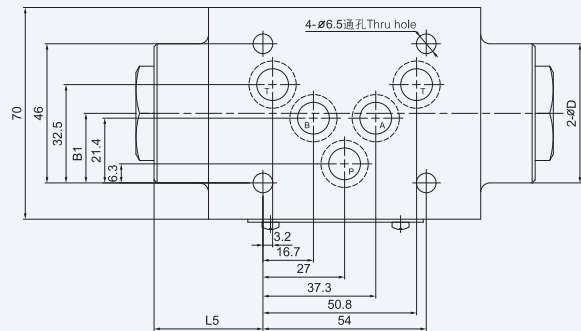
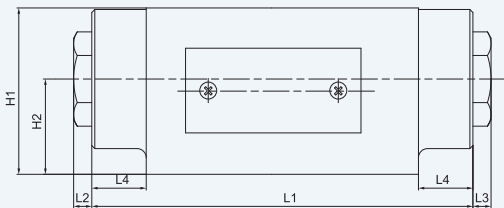

规格 Specification	参数 Parameter	D	B1	H1	H2	L1	L2	L3	L4	L5
DA - 03 - A		-	18.5	55	27.5	80	-	6	-	10
DA - 03 - B		-	18.5	55	27.5	80	6	-	-	16
DA - 03 - P		-	15.8	55	27.5	80	-	6	-	16
DA - 03 - T		-	23	55	27.5	100	-	6	-	19.5
DA - 03 - W		46	23	55	31.5	126	6	6	18	36
DA - 03 - WT		-	32.5	55	27.5	150	6	6	-	48

叠加式液控单向阀 Modular Pilot-Operated Check Valve



型号说明 Model description

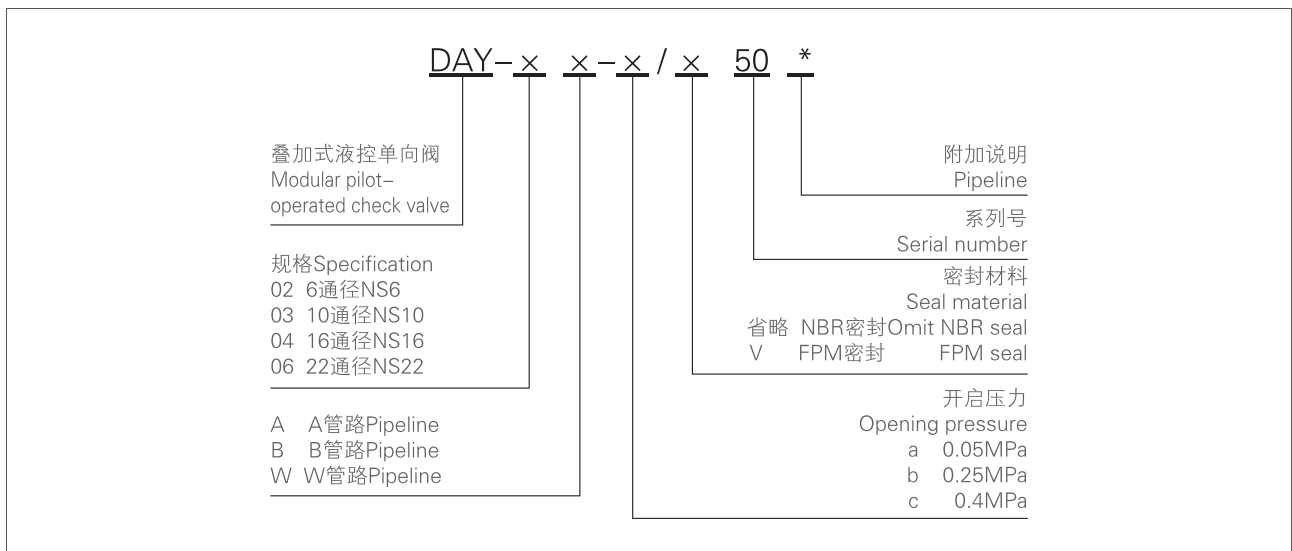

机能符号 Code symbol

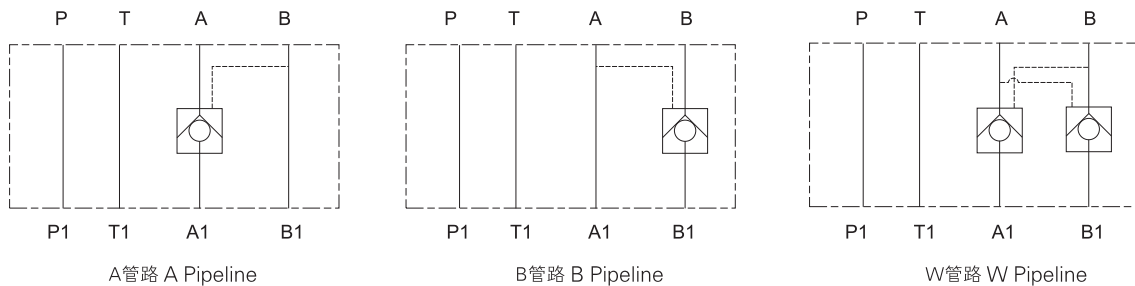

技术参数 Technical specification

规格Specification	参数Parameters	02	03	04	06
最高工作压力Maximum working pressure(MPa)		31.5			
最大流量Maximum flow(L/min)		60	100	200	360
工作介质Working fluid		矿物质液压油、磷酸酯Mineral oil, phosphate-ester			
介质温度范围Fluid temp(°C)		-20 ~ 70			
介质粘度范围Viscosity(mm ² /s)		a: 0.05 b: 0.25 c: 0.4			
重量Weight(Kg)		0.8	2	7	11.7

