

Electronic accessories

1 CONTROL LEVERS TYPE E-TLP



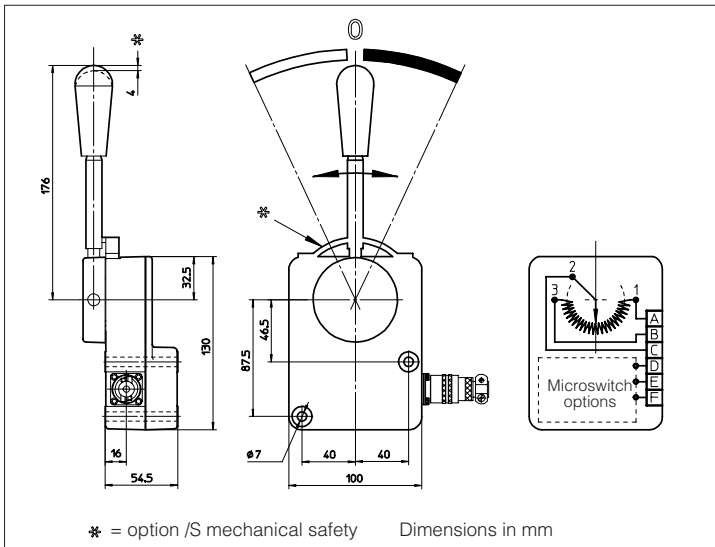

The control levers type E-TLP are compact units in a sealed case with a high accuracy potentiometer actuated by a lever and electrically connected to the outside through a standard sealed connector. They are available with mechanical and/or electrical safety, further with microswitches for possible contacts or auxiliary safety.

E-TLP	-	2	-	*	/	-	/	**
control levers								Design number
<p>potentiometer resistance: 2 = 2 KΩ</p> <p>lever position and control features: 0 = free lever without centering springs 1 = lever with center return by means of springs (range ± 30°) 2 = lever with return in external position by means of a spring (range 0 to 60°) 3 = lever with center return by means of a spring (range 0 to 30°)</p>								
<p>Options: - = basic version S = mechanical safety C = with one microswitch 2C = with two microswitches</p>								

2 TECHNICAL CHARACTERISTICS OF CONTROL LEVERS TYPE E-TLP

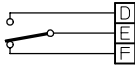
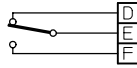
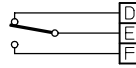
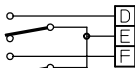

CONTACTS CHARACTERISTICS				
Voltage (V)	125 AC	250 AC	30 DC	115 DC
Max current with resistive load (A)	5	3	5	0,4
Max current with inductive load (A) (φ = 0,4)	3	2	3	0,05
Electric life	≥ 1.000.000 cycles			
Mechanical life	≥ 10.000.000 cycles			
Insulation resistance	100 MΩ			
Contact resistance	~ 15 MΩ			

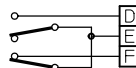
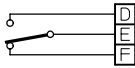
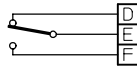
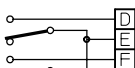
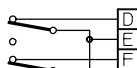
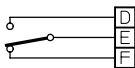
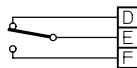
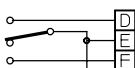
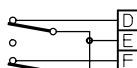
LEVER			LEVER POSITION		
TYPE	mechanical angle	electric angle	0		
E-TLP-2-0/C E-TLP-2-1/C	0±30°	0±15°			
E-TLP-2-0/2C E-TLP-2-1/2C	0±30°	0±15°			
E-TLP-2-2/C	60°	230°			
E-TLP-2-2/2C	60°	230°			
E-TLP-2-3/C	30°	115°			
E-TLP-2-3/2C	30°	115°			

3 MECHANICAL BEARING FRAMES FOR ELECTRONIC CARDS IN EUROCARD FORMAT

Mechanical bearing frames for rear mounting (only for single card) or for front mounting (for single card or set of cards) are available for electronic cards in Eurocard format (100x160).

3.1 Mechanical bearing frames for rear mounting

E-K

32M

2

E-K = bearing frame for single card

32M = rear panel fastening with 32 pins connector and terminal board for connections
 Execution for double driver E-ME-T-2*H (see tab. G170)

These frames allow an easy mounting and connections of single cards in Eurocard format; they are realized in anti-flame material (VDE 0209) and they have a 32 pins connector DIN 41612 form D with gold-plated contacts and terminal board for connections; a device for card locking is also fitted-in. Only for single card mounting. For mounting the card insert and push it to the end; for pulling out the card keep lift the light brown lock.

