

Electronic drivers type E-ME-AC

analog, Eurocard format, for proportional valves without transducer

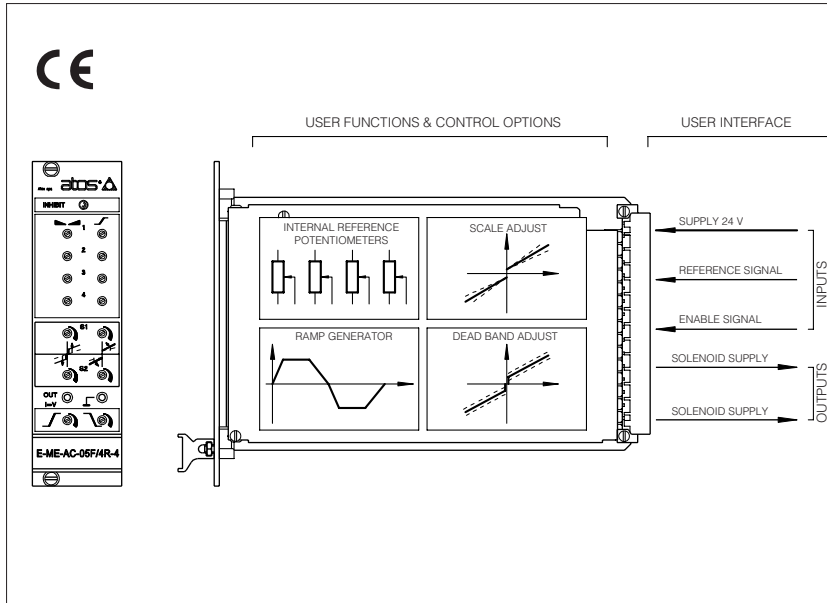

E-ME-AC drivers control the current to the solenoid of Atos proportional valves without pressure or position transducer, regulating the spool position, the flow or the pressure according to the electronic reference signal.

Features:

- bias and scale regulations by potentiometers
- symmetrical (standard) or dissymmetrical (/RR and /RR-4 options) rising and falling ramp generator
- factory pre-setted
- Eurocard format (DIN 41494 modular unit)
- 4 internally generated reference signals, selectable by external ON-OFF signals (-4, /RR-4, /4R-4 options)
- electronic filters on input and output lines
- CE marking granting the conformity to the EMC Directive (Electromagnetic Compatibility)
- both sides of the card with shielded cover with E faston connector

Applications:

Pressure, flow, position open or closed-loop regulation systems, according to the block diagram [2].

1 MODEL CODE

E-ME - AC - 01F

E-ME = Electronic driver in Eurocard format

AC = for proportional valves without transducer

01F = for single solenoid proportional valves
05F = for double solenoid proportional valves

****** /*****
 Set code (see 4.4)
 Series number

- Options:
- = standard symmetrical ramp
 - /RR = with adjustable dissymmetrical ramps
 - 4 = with 4 reference potentiometers
 - /RR-4 = with rising and falling ramps and 4 reference potentiometers
 - /4R-4 = with 4 ramps and 4 reference potentiometers
 - /I = suitable to receive current reference signal 4±20 mA (not suitable with -4, /RR-4, /4R-4 options)

2 BLOCK DIAGRAM

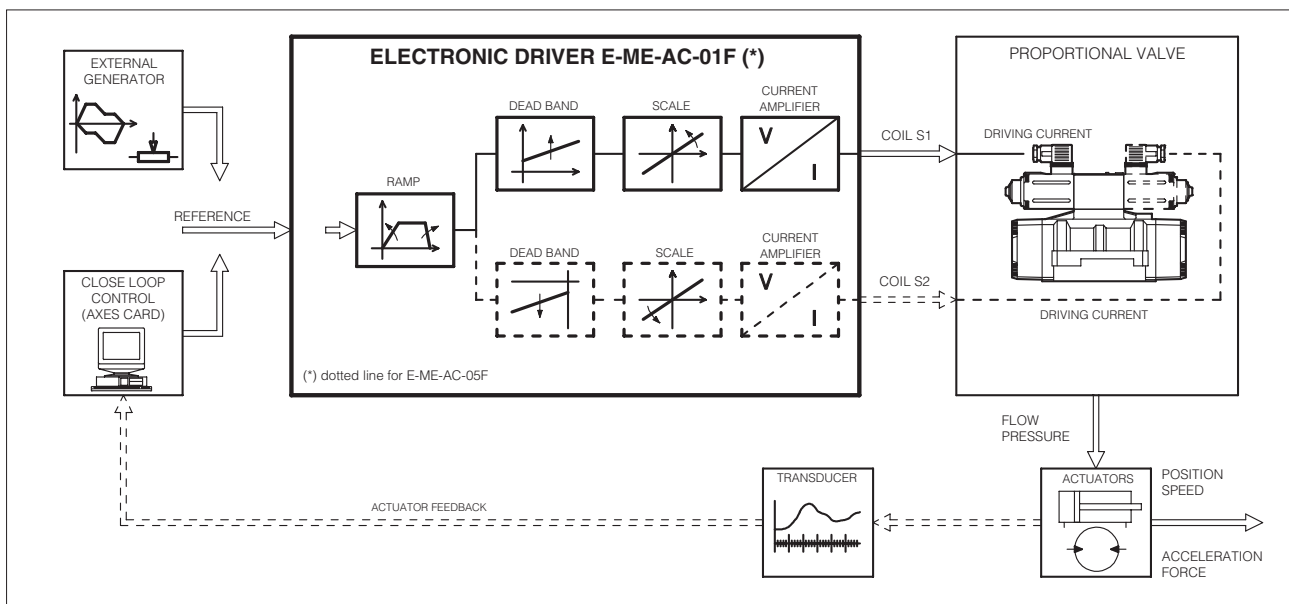

3 MAIN CHARACTERISTICS OF E-ME-AC ELECTRONIC DRIVERS

Power supply (positive at contacts 2a, 2c) (negative at contacts 4a, 4c)	Nominal: :24V _{DC} Rectified & filtered: :V _{RMS} = 21 ÷ 33 (max ripple = 2Vpp)
Max power consumption	50 W
Current supplied to solenoid	I _{max} = 3.3A square wave PWM type; (for ex-proof valves I _{max} = 2,5 A)
Nominal reference signal, factory preset	E-ME-AC-01F: 0 ÷ +5V at contact 12c (GND on 8a) E-ME-AC-05F: ± 5V at contact 12c (GND on 8a) 4 ÷ 20 mA for /I: at contacts 12c (+) and 8a (-)
Reference signal variation range (Scale adjust)	± 10V max ± 2,5V min
Input signal impedance	Voltage signal R _i > 50 KOhm - (/I option R _i = 316 Ohm)
Potentiometers supply	+5V / 50 mA at contact 10c and -5V / 20mA at contact 14c
Ramp time	5 sec. max (0 ÷ 100% of reference signal)
Enabling signal	V = 5 ÷ 24V _{DC} on contact 18a with led indicator on panel
Electrical wiring	Coil : 2 x 1 mm ² to 20 m 2 x 1,5 mm ² shielded to 40 mt
Card format	Europe 100x160 mm (Plug-in unit DIN 41494)
Card connector	Male DIN 41612 /D
Connector elements available	Type E-K-32M frame snap connector (see table G800) To be ordered separately
Operating temperature	0 ÷ 50°C (storage -20° ÷ +70°C)
Front panel dimensions	128,4 x 35,3 mm
Weight	540 g
Features	Rapid solenoid excitation and switching off. Outputs to solenoids protected against accidental short circuits

4 GENERAL SPECIFICATIONS

4.1 Power supply and wirings

The power supply must be appropriately stabilized or rectified and filtered. If the power supply is generated by a single phase rectifier, use a 10000 µF/40V capacitor; if pulse voltage is generated by a three phase rectifier, connect a 4700 µF/40V capacitor (see [13]).

Connect the reference signal to the main electronic control by means of shielded and twisted cables. Pay attention: the negative and the positive poles must not be exchanged each other. Shield the wirings to avoid electromagnetic noise (EMC).

It is suitable to keep the driver and its cables far from any electromagnetic radiation source (like cables where high currents flow, electric motors, transformers, relays, solenoids, portable radio-transmitter, etc.).

Wire the earth connection as shown in [13], according to CEI EN 60204-1 standards.

Connect the shield of the driver to the noiseless earth terminal (TE) [15].

4.2 Reference signal

The electronic driver is designed to receive voltage or current reference signals according to the following options:

- internal potentiometers mounted on board, see [13].
- external reference signals, see [5].

Note that drivers designed to receive current reference (options /I) have signal values in the range 4 to 20 mA and do not have mounted on board potentiometer option.

It is possible to use current option also for double channels drivers type E-ME-AC-05F using the reference inversion signal on contact 18c (5 ÷ 24 V_{DC}).

4.3 Monitor signal

This voltage output signal allows to measure the current supplied to the coil, read by a voltmeter on the front panel test points (see [9]). Reading scale is 1 mV = 1 mA.

To visualize the signals use voltmeters with impedance > 10 KΩ.

4.4 Set code

Basic calibration of the electronic driver is factory preset according to the proportional valve it has to be coupled with. These pre-calibrations are identified by a standard number in the model code as follows:

- | | |
|---------------------|--------------------------|
| 1 = RZGO, KZGO | 2 = RZMO.AG*ZO, LI*ZO |
| 3 = DHZO, DKZOR | 4 = DPZO-A-*5, DPZO-A-*7 |
| 6 = QV*ZO(R), LIQZO | |

For ex-proof valves, insert an "A" before the code of adjustment.

For example, the code of adjustment for RZGA is A1 (see table E120).

4.5 Calibrations/settings available to the user, see [6], [8], [9], [10], [11].

Scale

The Scale regulation, available on the front panel, permits to modify the relation between the reference signal and the regulated current to the solenoid.

Modifying this regulation (see [10], [11]) it is possible to fit the valve hydraulic behaviour to the effective system conditions; in addition, the two regulations available for double solenoid valves (driver E-ME-AC-05F) permit to set different hydraulic adjustments for positive and negative movements.

The Scale regulation is factory set at standard values depending to the proportional valve to be controlled and it is identified by the driver set code (see 4.4)

Bias

The bias regulations, available on the front panel, permit to set the correspondence between the electrical zero of the reference signal with the beginning of the valve's hydraulic regulation, compensating the dead band and the component's mechanical tolerances.

Modifying this regulation (see [10], [11]) it is possible to fit the valve hydraulic behaviour to the effective system conditions; in case of drivers for double solenoid valves (E-ME-AC-05F) the bias are active only when the reference signal is over the threshold value of ± 100 mV.

The Scale regulation is factory set at the standard values depending to the proportional valve to be controlled and it is identified by the driver set code (see 4.4)

Ramps

The ramp regulation, available on the front panel, permit to modify the time in which the regulated current reaches the set value in front of a step change of the reference signal.

The ramp regulation is factory set at value close to zero and it can be increased up to 5 sec max for a step change of the reference signal from 0% to 100%

5 EXTERNAL REFERENCE SIGNALS

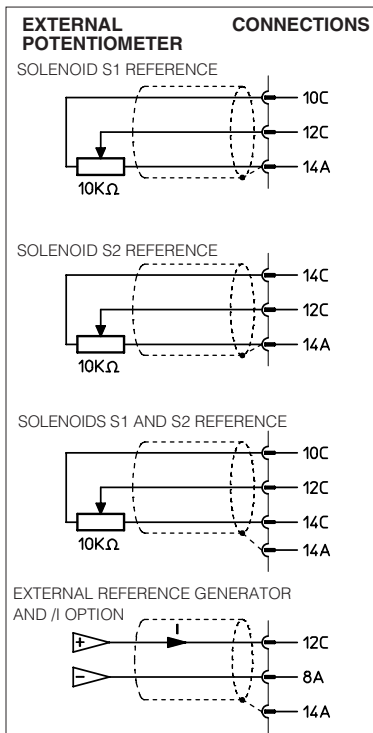

6 EXTERNAL RAMPS

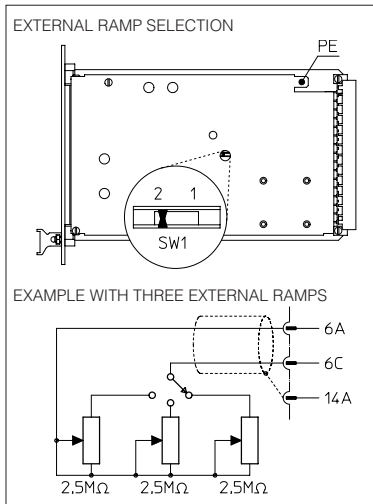

8 RAMPS AND SETTINGS

The available ramp regulations depend to the driver version:

- in the standard version it is available a single regulation for rise/fall ramp (P7)
- in the /RR version it is possible to separately regulate the rise ramp and the fall ramp (P7 and P17)

In the version /4R-4 it is possible to separately regulate the ramp for each of the internal reference signals (P11-P12-P13-P14).

External ramps, see [6]

This feature allows to regulate the ramp time by means of external potentiometers. In order to use this capability:

- set switch SW1 in position 2
- connect one or more external potentiometers as shown (use only 2,5 MΩ potentiometers).

Internal reference signals

In the version -, /RR-4 and /4R-4 the driver can self generate 4 different internal reference signals, selectable by means of 4 relevant on-off commands 24 V_{dc}, to be supplied to the contacts 22c, 24c, 24a, 22a (see scheme [13], [14]): each internal reference signal can be adjusted by means of a relevant potentiometer available on the front panel.

7 INSTALLATION AND START-UP

It is advisable to perform calibration procedures in the order given below.

7.1 Warning

- Never insert or remove the driver while the electronic system is powered on.
- Voltages must always be measured with reference to GND (connector contact 8a or front panel test point $\frac{1}{1}$).
- Refer to [9] to identify components mentioned in calibration procedures.

7.2 Start-up

Factory pre-set adjustments might not meet the desired requirements for the specific application and performances can be optimized by on-site re-adjustments of Bias, scale and ramps potentiometers, in sequence.

- Connect the electronic driver according to the desired connection diagram, [13], [14].

The current supplied to the coil can be measured by a voltmeter connected between the test points on the front panel.

For E-ME-AC-05F the channel enabled led (L5 or L6) shows the supplied coil.

Enabling signal, see [13], [14].

The electronic driver operate when the contact 18a is supplied with an enabling signal (usually 24V_{dc}). It could be useful in emergency conditions to inhibit the driver by zeroing this signal.

Bias adjustment (Dead band compensation), see [9], [10], [11].

- Supply a reference signal voltage (0V_{dc} for E-ME-AC-01F and $\pm 0,1V_{dc}$ for E-ME-AC-05F). Gradually turn bias potentiometer(s) until a movement of the controlled actuator is obtained
- Turn in the opposite direction until the actuator is stopped.

Scale adjustment, see [9], [10], [11].

Supply max reference voltage signal (for E-ME-AC-05F driver repeat for max negative voltage) in the specified range and turn scale potentiometer(s) until the actuator speed reaches the desired value.

Ramps, see [8], [9].

Turning the ramp potentiometer(s) clockwise, acceleration(s) and deceleration(s) can be reduced to obtain optimization of the complete system.

INTERNAL RAMPS - /RR OPTION

Reference from 0 to 100%

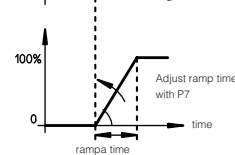
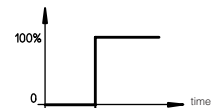

Reference from 100% to 0

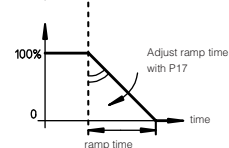
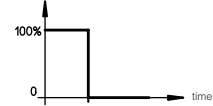

/4R-4 OPTION

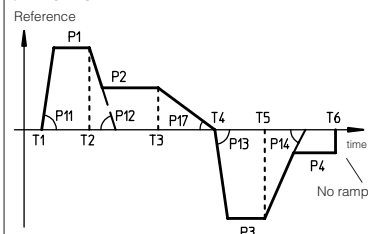

Time	Selected inputs				Active regulations		
	REF.1	REF.2	REF.3	REF.4	6a-6c	Speed	Ramp
T1	ON	OFF	OFF	OFF	Open	P1	P11
T2	ON	ON	OFF	OFF	Open	P2	P12
T3	OFF	OFF	OFF	OFF	Open	EXT.REF.	P17
T4	OFF	OFF	ON	OFF	Open	P3	P13
T5	OFF	OFF	ON	ON	Open	P4	P14
T6	OFF	OFF	OFF	OFF	Close	EXT.REF.	(tr=0)

9 E-ME-AC-05F TOPOGRAPHICAL VIEW OF REGULATIONS

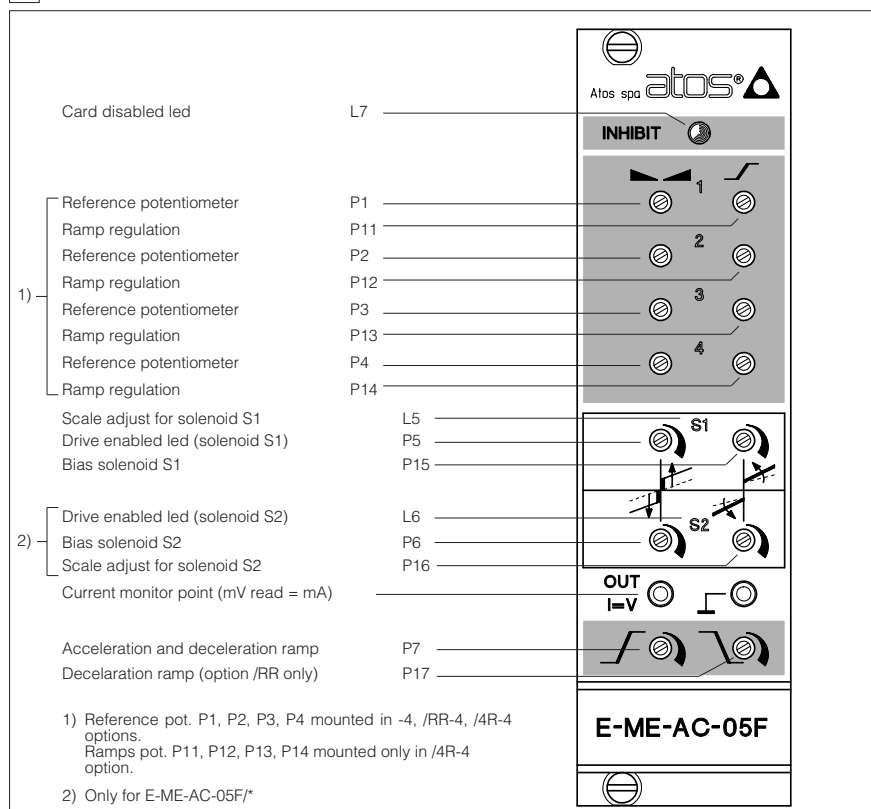

10 E-ME-AC-01F ADJUSTMENT

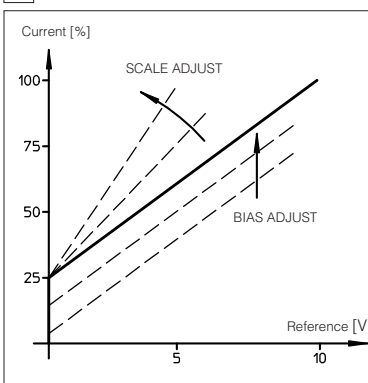

11 E-ME-AC-05F ADJUSTMENT

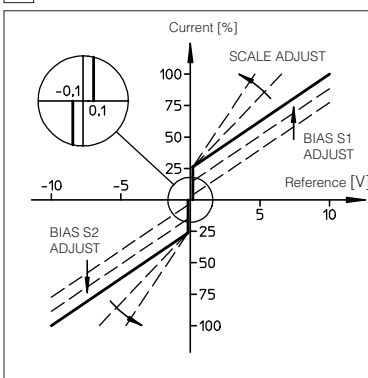

12 IMPORTANT INSTRUCTIONS

ELETTROMAGNETIC COMPATIBILITY

Atos electronic drivers and proportional valves are designed according to the 89/336 directive (Electromagnetic Compatibility) and according to EN 50081-2 (Emission) and EN 50082-2 (Immunity) standards. The electromagnetic compatibility of electronic drivers is valid only for wirings realized according to the typical electric connections shown in the technical table of the driver. The device must be verified on the machine because the magnetic field may be different from the test conditions.

SAFETY

The electrical signals (for example reference signals, feedback and enable signal) of electronic drivers must not be used to realize safety conditions of the machine. This is in accordance with the provisions of european directives (Safety requirements of fluid technology systems and components-hydraulics, draft prEN 982). Special attention must be paid to switch-on/switch-off of electronic drivers because they could produce uncontrolled movements of actuators operated by the proportional valves.

13 WIRING BLOCK DIAGRAM

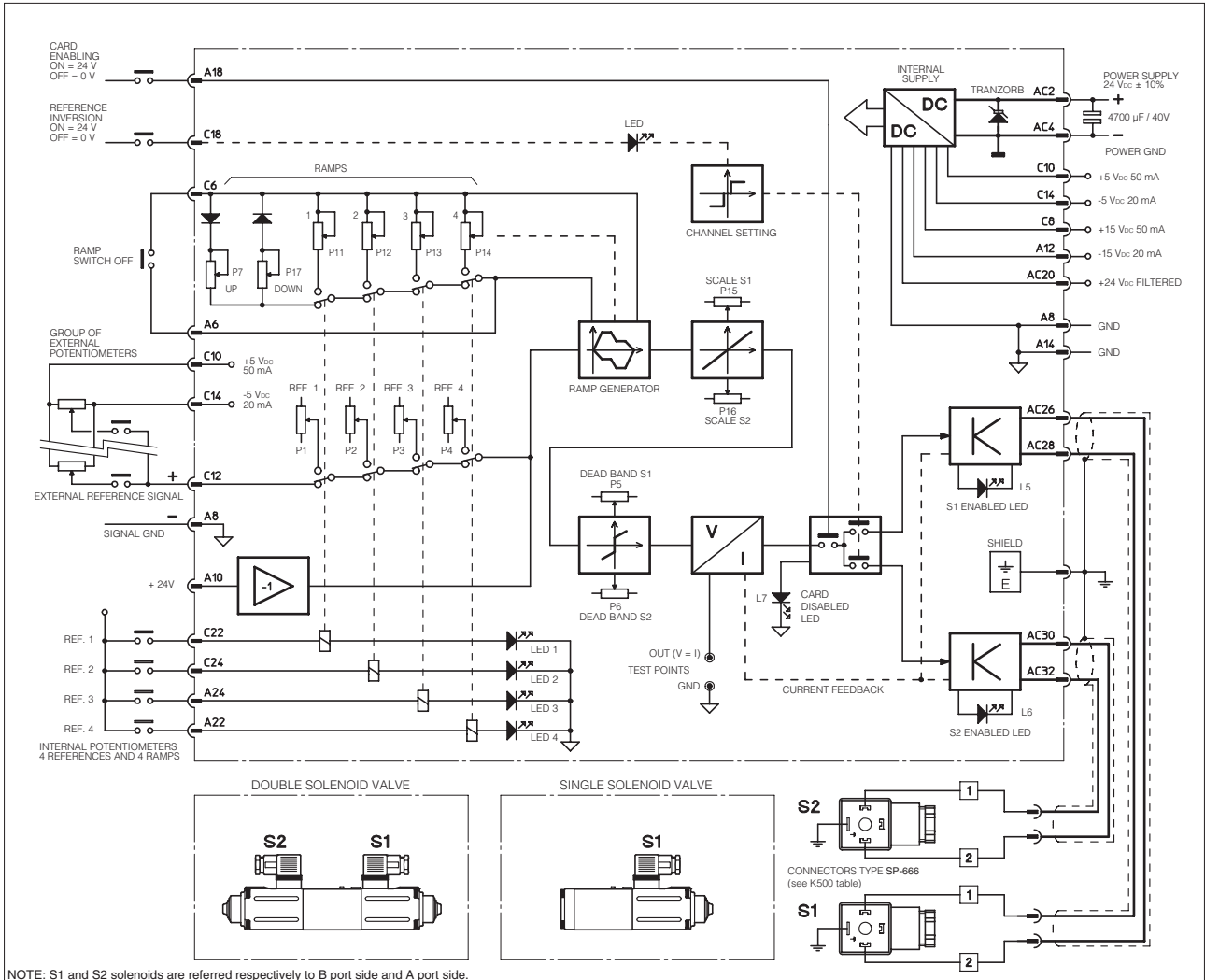

14 GENERAL CONNECTIONS

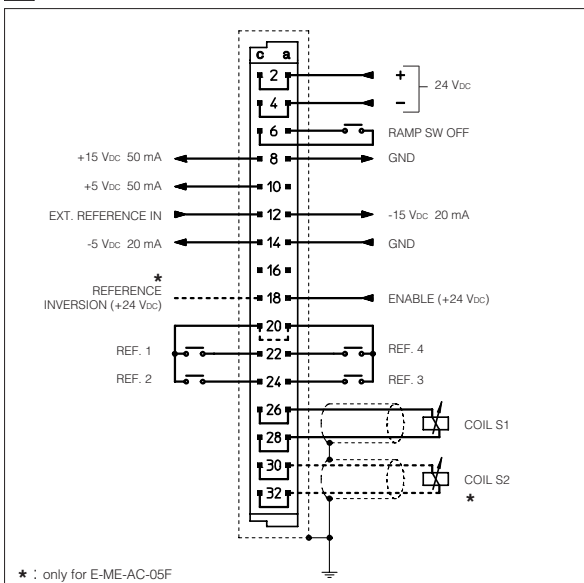

15 EARTH CONNECTIONS

