











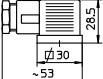
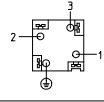

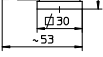
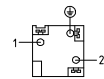
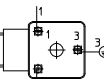
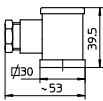
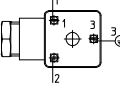

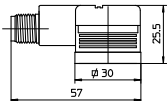
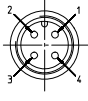

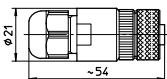

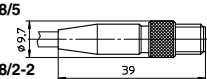



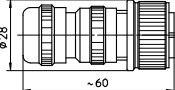



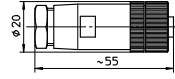

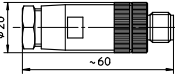

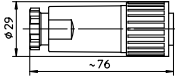
Electric/electronic connectors

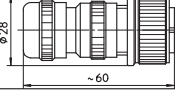
1 ELECTRIC CONNECTORS FOR ON/OFF AND PROPORTIONAL VALVES



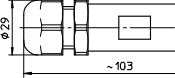







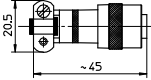

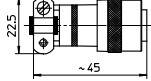
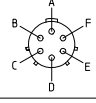

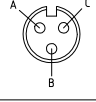



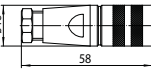
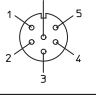

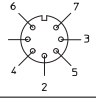
CODE AND DIMENSIONS	APPLICATION	ELECTRICAL TERMINAL VIEW (1)	SOCKET INTERFACE	CABLE GLAND Ø CABLE	REFERENCE RULES
SP-345 	Standard connector S (signal) on ZO(R)-T and ZO-L proportional valves Sensor connector for DH*/FI Connector for position trasducer type E-TH-*			PG7 ø 4 ÷ 6 mm	Protection degree IP 65 DIN 40050
SP-664 	Connector for pressure switch type MAP			PG11 ø 8 ÷ 10 mm	DIN 43650-A/ISO 4400 Protection degree IP 65 DIN 40050
SP-666 (2) 	Standard connector for ON/OFF valves, DC or AC power Standard connector (power) for ZO(R)-A, ZO(R)-T, ZO-L proportional valves				
SP-667-24 (-110, -220)	Option transparent connector for ON/OFF valves with built-in led				
SP-669 (2) 	Option connector for ON/OFF valves with built-in rectifier bridge for supplying DC coils by AC current			PG11 ø 8 ÷ 10 mm	DIN 43650-A/ISO 4400 Protection degree IP 65 DIN 40050
SP-666/M12 	Optional sensor connector for safety valves			M12x1	DIN 43650-A/ISO 4400 (valve interface) M12x1 (user interface) Protection degree IP 65 DIN 40050
SP-ZH-4P/68 	Sensor connector for ON/OFF safety cartridges type JODL/FI			PG09 ø 6 ÷ 8 mm	M12 IEC 60947-5-2 Protection degree IP 65 DIN 40050
SP-ZH-4P-M8/5 	Pressure transducer connector for digital integral electronics with options /SL, SP			Moulded on cable with 5 mt lenght	Protection degree IP 67 DIN 40050
SP-ZH-4P-M8/2-2	Pressure transducer connector for digital integral electronics with option /SF				
SP-ZM-4P 	Connector for transducer on proportional valves in military execution.			PG11 ø 8 ÷ 10 mm	According to Mil-C-50516 Protection degree IP 66 DIN 40050
SP-ZS-4P (3)	Connector for transducer on proportional valves in marine execution.				
SP-ZH-5P 	Communication connection for proportional valves with digital integral electronic drivers and CANopen interface Sensor connector for ON/OFF safety cartridges type JODL/FI/T			PG9 ø 6 ÷ 8 mm	M12-IEC60947-5-2 Protection degree IP 67 DIN 40050
SP-ZH-5P/BP 	Communication connection for proportional valves with digital integral electronic drivers with PROFIBUS-DP interface			PG9 ø 6 ÷ 8 mm	M12-IEC60947-5-2 Protection degree IP 67 DIN 40050 Reverse Key
SP-ZH-7P 	Standard single - 7 pins, plastic glass fiber reinforced, connectors for proportional valves with integral electronics (3)			PG11 ø 8 ÷ 10 mm	DIN 43563-BF6-3-PG11 Protection degree IP 67 DIN 40050
SP-ZM-7P 	Connector for transducer on proportional valves in military execution.			PG11 ø 8 ÷ 10 mm	According to Mil-C-50516 Protection degree IP 66 DIN 40050
SP-ZS-7P (3)	Connector for transducer on proportional valves in marine execution.				
SP-ZH-12P 	Connector - 12 pins, plastic glass fiber reinforced, connectors for proportional valves with integral electronics			PG16 ø 6 mm x 2 cable	DIN 43563* Protection degree IP 65 DIN 40050

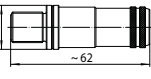
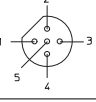
(1) Connection of electrical terminals must be realized according to instructions of the specific technical table of the valve.

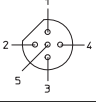

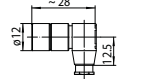
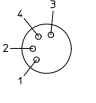

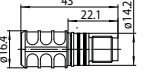
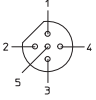
(2) These connectors are black. White versions are also available (**SP-666/A, SP-669/A**)

(3) As SP-ZM-*P plus epoxy painting

2 CONNECTORS FOR SPECIAL EXECUTIONS

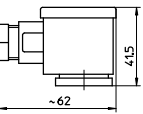
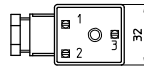
CODE AND DIMENSIONS	APPLICATION	ELECTRICAL TERMINAL VIEW (1)	SOCKET INTERFACE	CABLE GLAND Ø CABLE	REFERENCE RULES
SP-PT-06E-8-3S 	Optional /H connector for intrinsic safety solenoids			ø 3,2 mm	According to Mil-C-26482 Protection degree IP 67 DIN 40050
SP-PT-06E-10-6S 	Standard military connector for joysticks type E-TLP			ø 4,8 mm	According to Mil-C-26482 Protection degree IP 67 DIN 40050
SP-ZM-3P SP-ZS-3P (3) 	Connector for military solenoids Connector for marine solenoids			PG11 ø 8 ÷ 10 mm	According to Mil-C-5015 Protection degree IP 66 DIN 40050
SP-PT-06W-8-4S 	Standard military connector for CKP and CKV servocylinders with position transducer			ø 4,2 ÷ 5,8 mm	According to Mil-C-26482 Protection degree IP 67 DIN 40050
SP-ST-CO-9131-D06-PG9 	Female connector - 6 pins for CKF and CKM servocylinders with analog position transducer and digital with CANopen interface			PG09 ø 6 ÷ 8 mm	DIN 45322 Protection degree IP 67 DIN 40050
SP-ST-CO-9131-D07 	Female connector - 7 pins for CKM servocylinders with digital SSI position transducer			ø 8 mm	DIN 45329 Protection degree IP 67 DIN 40050
SP-560884 	Male connector - 5 pins for CKM servocylinders with digital position transducer with PROFIBUS DP interface Connector for bus output			ø 6,5 ÷ 8,5 mm	M12 IEC 60947-5-2 Protection degree IP 67 DIN 40050
SP-560885 	Female connector - 5 pins for CKM servocylinders with digital position transducer with PROFIBUS DP interface Connector for bus input			ø 6,5 ÷ 8,5 mm	M12 IEC 60947-5-2 Protection degree IP 67 DIN 40050
SP-560886 	Female connector - 4 pins for CKM servocylinders with digital position transducer with PROFIBUS DP interface Connector for power supply			ø 5 mm	M8 IEC 60947-5-2 Protection degree IP 67 DIN 40050
SP-560888 	Female connector - 5 pins for CKM servocylinders with digital position transducer with PROFIBUS DP interface Connector for bus terminator			-	M12 IEC 60947-5-2 Protection degree IP 67 DIN 40050

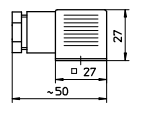
3 ELECTRONIC CONNECTORS FOR ON/OFF VALVES

CODE AND DIMENSIONS	APPLICATION	ELECTRICAL TERMINAL VIEW (1)	SOCKET INTERFACE	CABLE GLAND Ø CABLE	REFERENCE RULES
E-SD/AC 	Electronic connector which eliminate electric disturbances when AC solenoid valves are deenergized Power supply: 110/50, 115/60, 220/50, 230/60 VAc			PG11 ø 8 ÷ 10 mm	DIN 43650 Protection degree IP 65 DIN 40050
E-SD/DC 	Electronic connector which eliminate electric disturbances when DC solenoid valves are deenergized Power supply: 12, 24, 48 Vdc			PG11 ø 8 ÷ 10 mm	DIN 43650 Protection degree IP 65 DIN 40050

(1) Connection of electrical terminals must be realized according to instructions of the specific technical tables of the valve.